

ELKAY[®]

SPECIFICATIONS

Commercial Faucet Model LK940GN05T4H Wall Mount 8" Center Gooseneck 5"

GENERAL FEATURES

- Quarter turn ceramic disc cartridge
- Solid brass construction
- Chrome finish
- Replacement cartridge A70001 for cold
- Replacement cartridge A70002 for hot
- Includes spout swing restriction pin
- 1/2" NPT Female Inlets

COMPLIES WITH:

- ASME/ANSI A112.18.1
- CSA B125-01
- NSF/ANSI 61
- ADA
- UPC/CUPC
- IAPMO Listed

Wristblade Handle 4 inch, Two Piece

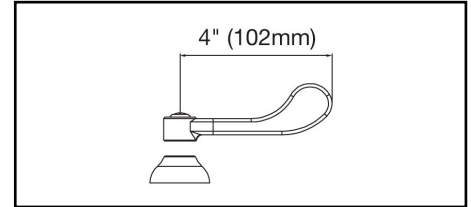

Replacement Handle A55387
Replacement Escutcheon A55390

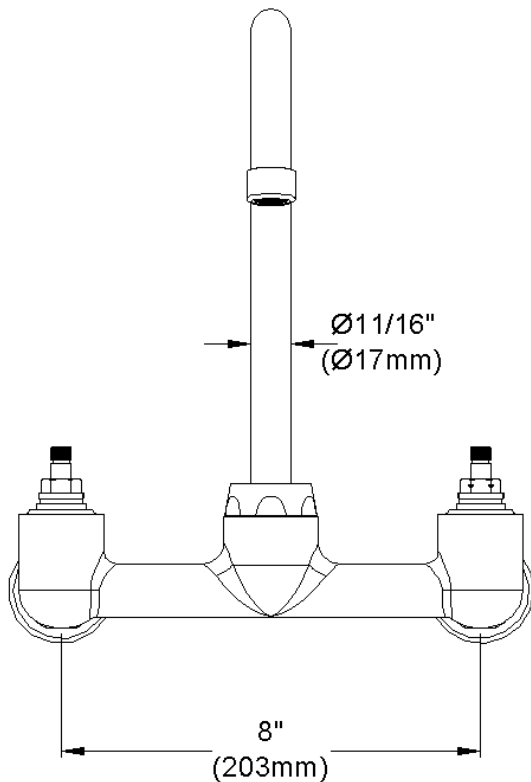

FRONT VIEW

(shown less handles)

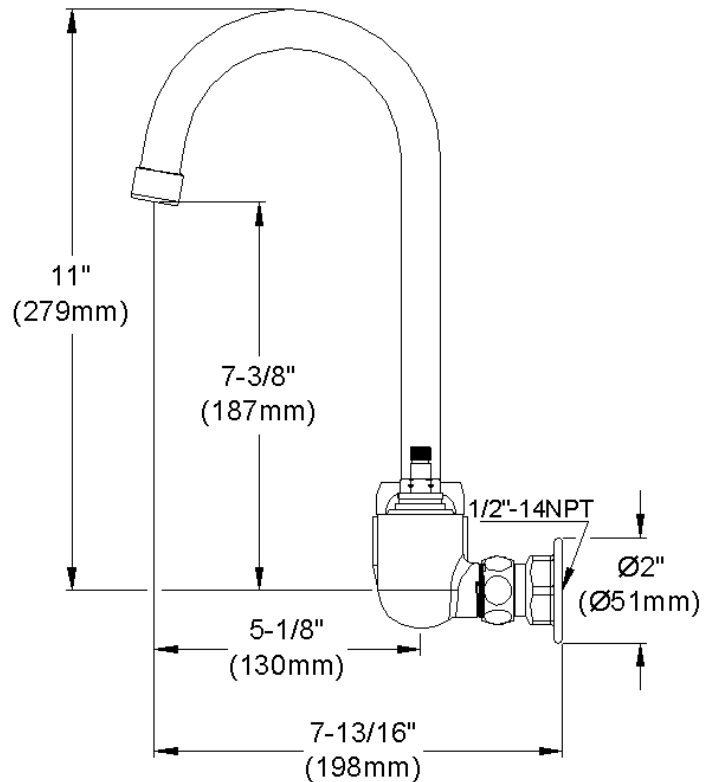

SIDE VIEW

Job Name:	Item #:
Notes:	
Architect/Engineer Approval:	Date: 10/22/2005

For warranty information go to www.elkayusa.com