

PRODUCT SPECIFICATIONS

Elkay Commercial Electronic Sensor Scrub/Handwash Battery Powered Deck Mount Faucet Chrome. Faucet has a flow rate of 2.2 GPM, and is made of Chrome-plated Brass material, with a Electronic Control Module valve. Faucet requires 1 faucet holes.

Mounting Type:	Deck Mount
Special Features:	Solid Brass Construction Hands Free Sensor Activated
Finish:	Chrome (CR)
Handle Type:	Sensor Operated (Hands Free)
Deck Clearance:	7-5/16"
Spout Reach:	5-5/8"
Spout Height:	11-5/8"
Hole Drillings:	1
Material:	Chrome-plated Brass
Valve Type:	Electronic Control Module
Valve Connection:	1/2" NPT Female
Flow Rate:	2.2 GPM
Spout Swing Rotation:	0°
Spout Type:	Gooseneck

Special Note: in-line filter with clean out trap and flexible supply hose.



Chrome
(CR)



Included with Product: AC plug-in and battery holder with 4 AA batteries pre-installed

AMERICAN PRIDE. A LIFETIME TRADITION.
Like your family, the Elkay family has values and traditions that endure. For almost a century, Elkay has been a family-owned and operated company, providing thousands of jobs that support our families and communities.

Product Compliance: ADA & ICC A117.1
ASME A112.18.1/CSA B125.1
NSF 61
NSF 372 (lead free)



Complies with ADA & ICC A117.1 accessibility requirements when installed according to the requirements outlined in these standards.

[Clean and Care Manual \(PDF\)](#)
[Installation Instructions \(PDF\)](#)
[Limited Warranty \(PDF\)](#)

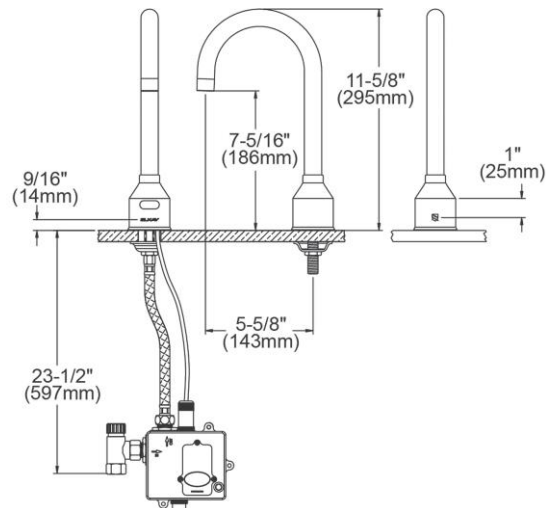

PART: _____ QTY: _____
PROJECT: _____
CONTACT: _____
DATE: _____
NOTES: _____
APPROVAL: _____

In keeping with our policy of continuing product improvement, Elkay reserves the right to change product specifications without notice. Please visit elkay.com for the most current version of Elkay product specification sheets. This specification describes an Elkay product with design, quality, and functional benefits to the user. When making a comparison of other producers' offerings, be certain these features are not overlooked.

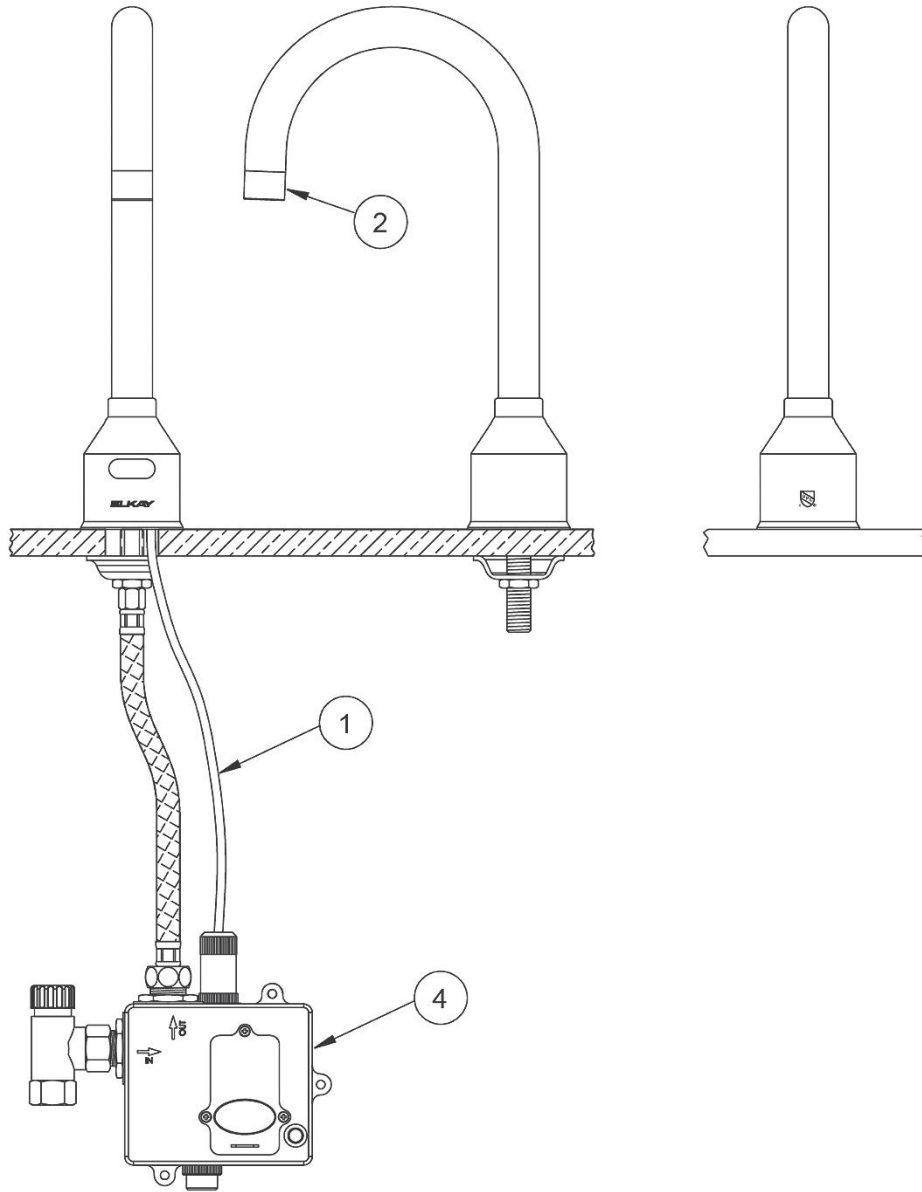

ITEM	PART NUMBER	PART DESCRIPTION
1	98541C	SENSOR ASSEMBLY
2	98542C	AERATOR ASSEMBLY
3	1000003975	POWER ADAPTER (NOT SHOWN)
4	1000003976	CONTROL BOX

In keeping with our policy of continuing product improvement, Elkay reserves the right to change product specifications without notice. Please visit elkay.com for the most current version of Elkay product specification sheets. This specification describes an Elkay product with design, quality, and functional benefits to the user. When making a comparison of other producers' offerings, be certain these features are not overlooked.